

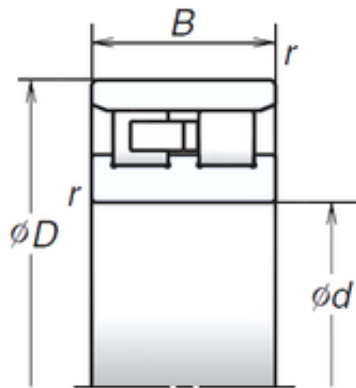

FML ske Manufacturing Co., Ltd



*Cylindrical Bore

200 mm x 280 mm x 60 mm NSK NN3940MB
cylindrical roller bearings

Bearing No. NN3940MB

Size	200x259x60 mm
Bore Diameter	200 mm
Outer Diameter	259 mm
Width	60 mm
d	200 mm
D	280 mm
E	259 mm
B	60 mm
C	60 mm
r min.	2,1 mm
Weight	10,6 Kg
Basic dynamic load rating (C)	420 kN
Basic static load rating (C0)	0 815 kN
(Grease) Lubrication Speed	3 200 r/min

NN3940MB Bearing 2D drawings and 3D CAD models