

KOYO UCF319 bearing units

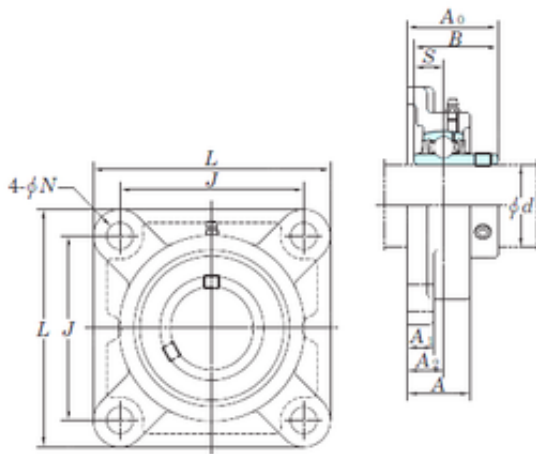

Bearing No. UCF319

Bore Diameter	95 mm
d	95 mm
A0	121 mm
A	94 mm
A1	30 mm
B	103 mm
J	228 mm
L	290 mm
N	35 mm
S	41 mm
Bolt (G)	M30
A2	59 mm
Weight	21,6 Kg
Basic dynamic load rating (C)	153 kN
Basic static load rating (C0)	119 kN
Bearing No.	UCF319
Bolt size	M30
Cr	153
C0r	119
f0	13.3
(Refer.)Unit mass(kg)	21.6
Nipple size	R1/8

UCF319 Bearing 2D drawings and 3D CAD models