

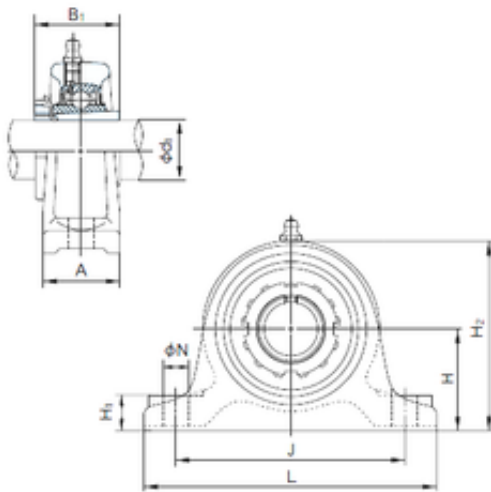

FML ske Manufacturing Co., Ltd

NACHI UKIP212+H2312 bearing units



Bearing No. UKIP212+H2312

Bore Diameter	55 mm
Width	80 mm
d	55 mm
A	70 mm
B1	62 mm
H	80 mm
H1	30 mm
H2	155 mm
J	200 mm
L	260 mm
N	22 mm
Bolt (G)	M20

UKIP212+H2312 Bearing 2D drawings and 3D CAD models