

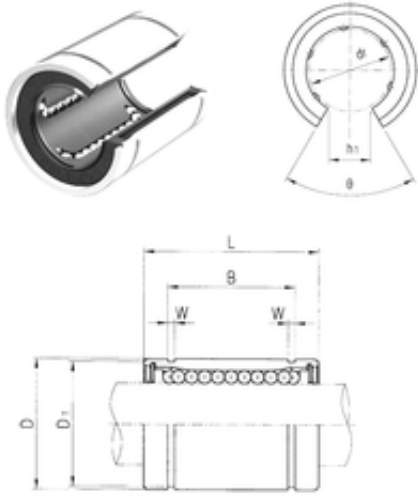

FML ske Manufacturing Co., Ltd



35 mm x 52 mm x 49,5 mm Samick LM35UUOP linear bearings

Bearing No. LM35UUOP

Size	35x52x49.5 mm
Bore Diameter	35 mm
Outer Diameter	52 mm
Width	49,5 mm
d	35 mm
D	52 mm
h1	17 mm
B	49,5 mm
L	70 mm
W	2,1 mm
	50 mm
Weight	0,39 Kg
Basic dynamic load rating (C)	1,66 kN

LM35UUOP Bearing 2D drawings and 3D CAD models